

# LUXOMAT® LC-plus 280

## Operating and mounting instructions for motion detector LUXOMAT® LC-plus 280

### 1. Mounting preparations

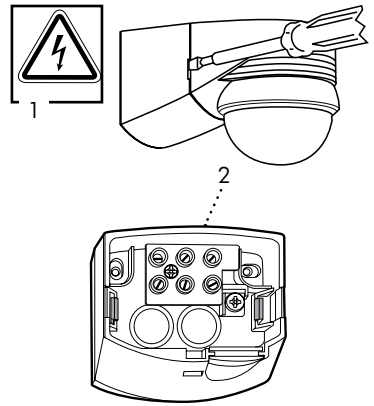

- 1) **Caution:** have all work involving the 230 V mains supply carried out by a qualified electrician! Before starting disconnect the mains! Please be aware, that the LUXOMAT® LC-plus 280 is not suitable as an intrusion detector, since it is not equipped with a tamper contact.
- 2) Socket base corner mounting

**Important:** The LUXOMAT® LC-plus 280 has to be mounted in such a way, that the adjusting elements / rotary regulators are always pointed downward.

### 2. Mounting types

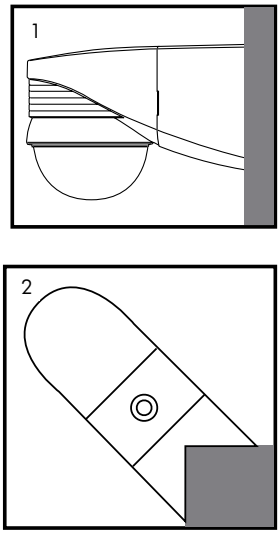

- 1) Wall mounting
- 2) Outside corner mountable with plug-in socket (included)

### 3. Plug-in socket

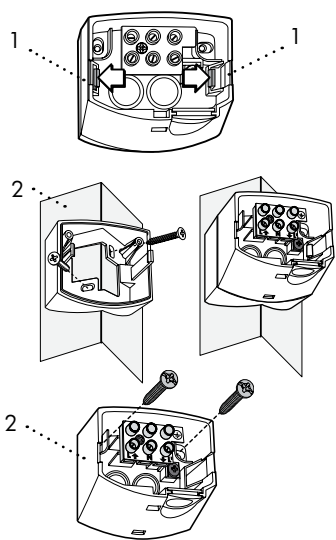

- 1) Press here for separation of terminal case and plug-in socket
- 2) Mount the plug-in socket with two screws and the enclosed seal rings on a firm base (Pay attention to inserting of the connection cable, see point 4)

### 4. Inserting of the connection cable

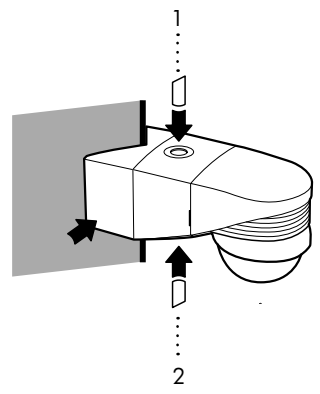

- 1) Connection cable from top down
- 2) Connection cable from below
- 3) Terminal markings (Wiring diagrams see point 16)

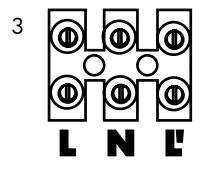

### 5. Putting into operation / Settings

**Self test cycle**  
After mounting and connecting the 230 VAC supply voltage, the LED flashed for 1 min. to show a self testing unit. Then the unit is ready for operation and the settings can be made manually or with remote control (see point 11).

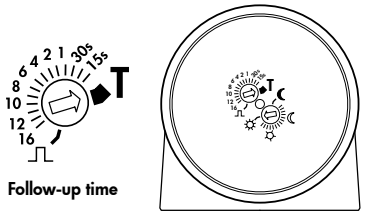

Follow-up time

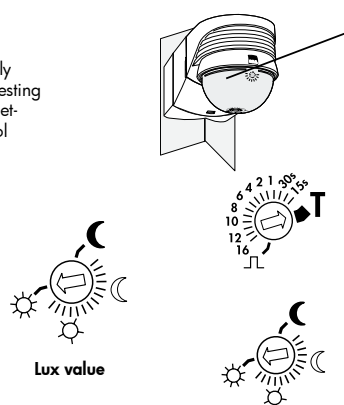

**LED Functional display**  
Slow flashing: EEPROM empty  
Fast flashing: EEPROM is written  
During the self-testing cycle, the LUXOMAT® LC-plus 280 will only react to commands "RESET" and "LIGHT OFF"

**Follow-up time**  
Test operation, 15 sec. ... 16 min., Pulse operation (Test operation: range testing, detector switches on/off the lighting at any recognized movement)

**Lux value**  
Night operation...Dusk...Day operation (Day operation: light sensor inactive, switching at any brightness value)

### 6. Factory settings



On delivery the potentiometers are adjusted in position "TEST" and "SUN" symbol (daytime operation). With this adjustments the following regular values are active:  
Follow-up accommodation: 3 min.  
Lux value: approx. 20 Lux  
**Reset:** The adjusting into "Factory settings" from any other position causes a "Reset" of the device. That means all parameters are resetted into factory settings (fast LED-flashing).

### 7. Sensor head optics

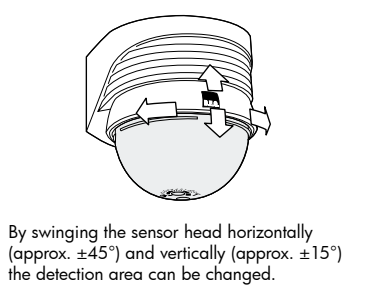

By swinging the sensor head horizontally (approx. ±45°) and vertically (approx. ±15°) the detection area can be changed.

### 8. Sensitivity adjustment (mounting height 2.50 m; mounting height min. = 2.00 m)

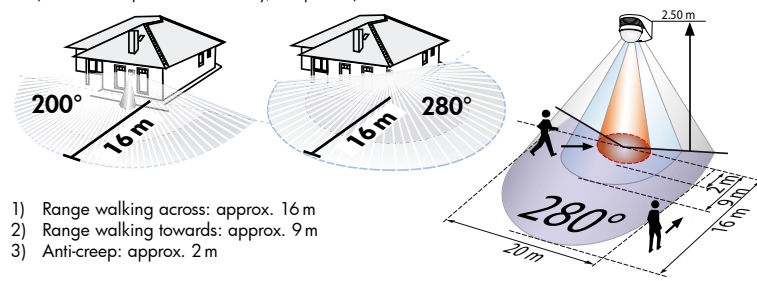

- 1) Range walking across: approx. 16 m
- 2) Range walking towards: approx. 9 m
- 3) Anti-creep: approx. 2 m

### 9. Exclude sources of interference

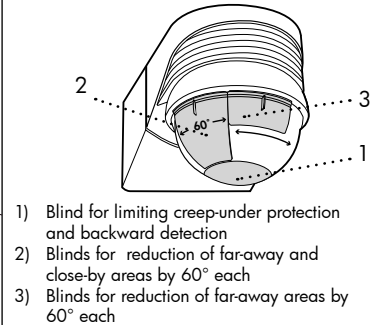

- 1) Blind for limiting creep-under protection and backward detection
- 2) Blinds for reduction of far-away and close-by areas by 60° each
- 3) Blinds for reduction of far-away areas by 60° each

### 10. Mounting place

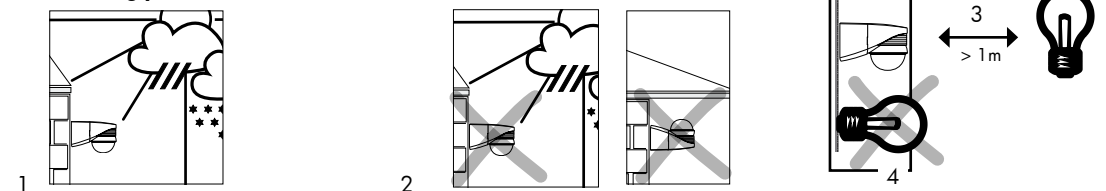

- 1) If possible mount unit on a safe place (wall or ceiling mount).
- 2) Influence of weather reduces the lifetime of the unit. Please take care to mount correctly.
- 3) Minimum distance to switched lighting, frontally or laterally to device: 1 m
- 4) Never mount the connected lights below the motion detector!



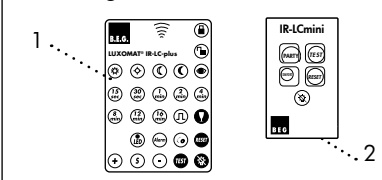









### 11. Settings of remote control



- 1) LUXOMAT® IR-LC-plus (accessory, see point 20)
  - 2) LUXOMAT® IR-LCmini (accessory, see point 20)
- Caution:** Settings with remote control subscribe the settings by courtesy of potentiometers (see point 5) (for description see point 12).

## 12. Functions of LUXOMAT® IR-LC-plus

### Unlocking device

-  **Lux value: Day operation**  
light sensor inactive, switching at any brightness value
-  **Lux value: approx. 100 Lux**  
Onset of dusk
-  **Lux value: approx. 25 Lux**  
Advanced dusk
-  **Lux value: approx. 2 Lux**  
Darkness
-  **Automatic reading in the current light value**  
Individual light value  
2 - 2500 Lux
-  **Follow-up time**  
15 sec. up to 16 min.
-  **Impulsfunction<sup>1)</sup>**  
1 sec. ON, 9 sec. OFF
-  **Walk test**  
Switching ON/OFF
-  **Alarm function**  
Switching ON/OFF, (ON for 30 sec., OFF for 1 sec., then normal operation)
-  **Vacation- and comfort function**  
Switching ON/OFF  
On: By achieving the Lux value 1 hour daylight independent of movements, then normal operation (switching time changeable, see point 15)
-  **Sensitivity adjustment**  
~ +15%, ~ -30%
-  **Reset**  
Erasing of all of the values set using the remote control. (Then potentiometer-settings active, see point 5)

### Lock device

-  **Double Locking (sabotage protection)**  
Locking of IR-RC-reception. After locking the device press "Locking" again during a period of 5 sec. (reset see point 6)

-  **Test operation**  
Switches the light ON/OFF when movement is detected.

-  **Light ON for 12h<sup>2)</sup> / Light OFF for 12h**  
By pressing once the party button, the light is switched on for a period of 12 hours. By pressing the party button twice, the light remains switched off until the next evening (see point 14).

-  **Light OFF**  
Switches the light ON again when movement is detected.

-  **Reset**  
Light OFF, then automatic mode

**1)** As soon as the function "Chime/ Impulse" is activated, the following functions will be blocked: Alarm function, Light ON for 12 hrs / Light OFF for 12 hrs, Vacation- and comfort function

**2)** Light ON for 12h can also be activated by disconnection mains twice within 2 - 4 sec.

## 13. Functions of LUXOMAT® IR-LCmini

-  **Test operation**  
Switches the light ON/OFF when movement is detected.

-  **Light ON for 12h / Light OFF for 12h**  
By pressing once the party button, the light is switched on for a period of 12 hours. By pressing the party button twice, the light remains switched off until the next evening (see point 14).

-  **Light OFF**  
Switches the light ON again when movement is detected.

-  **Vacation- and comfort function**  
Switching ON/OFF  
On: By achieving the Lux value 1 hour daylight independent of movements, then normal operation (switching time changeable, see point 15)

-  **Reset**  
Light OFF, then automatic mode

### 14. Activation "Light OFF"

Because of the sabotage protection the function "Light off" is deactivated in the factory. When required it must be activated again:

1. Mains to be disconnected
2. Mains to be connected - a self test cycle of 60 sec. starts (the LED is flashing, see point 5).
3. Activation/deactivation of the function "Light Off" can be done only during the self testing cycle

-  For activation of the function "Light OFF" the button "Light OFF" must be pressed during the self testing cycle (the LED will flash quickly).

-  For deactivation "Light OFF" the button "Reset" must be pressed during the self testing cycle (the LED will flash slowly).

**Caution:** The implementation of "Reset" with potentiometers (see point 6) or with remote control (see point 12) does not influence the activation/ deactivation of the function "Light OFF"

### 15. Vacation- and comfort function

The duration of the on-period can be adjusted:

1. "Unlock" unit with remote control
2. The button "Co" to be operated. The LED flashes for 10 sec.
3. During these 10 seconds the duration of the light-on period can be selected: from e.g. 15 sec. = 15 min. up to 16 min. = 16 hrs.
4. The unit to be locked with the button "Lock".
5. "Vacancy/Comfort" is active now (deactivation see point 12)

**Caution:** If the "Vacation- and comfort function" is active or with lower deviation of the Lux value the LC-plus turns on the light again after a time delay of 60 sec.

## 16. Wiring diagrams

**Standard operation (with optional arc extinctions kit)**  
Optional extension for switching of parallel inductors, rocker switches, fluorescent lamps etc.

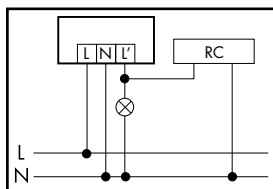

**Terminal connection for parallel operation**  
We recommend max. 5 motion detectors.

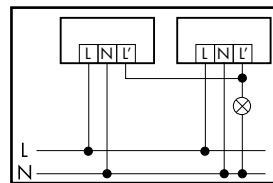

**Permanent light operation with external push button**  
Additionally manual switching is possible. The NC-contact is to press for approx. 0.5 - 2 sec.

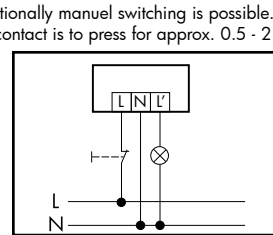

**Permanent light operation with external switch**  
Switching is manually possible (permanent light operation). Caution: Light has to switched off manually.

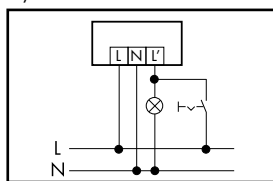

## 17. Dimensions (mm)

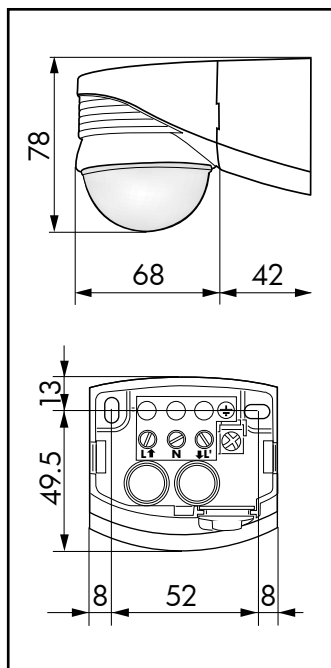

## 18. Technical data

**Power supply:** 230V ~ +6% -10%  
**Switching power:**  
2000W, 250V, (cos(φ)= 1)  
1000 VA, 250V, (cos(φ)= 0.5)  
**Range:** approx. 16 m  
**Time settings:** Impuls, 15 sec. - 16 min.  
**Photo electric switch:** approx. 2 - 2500 Lux  
**Factory settings:** follow-up accommodation 3 min., photo electric switch approx. 20 Lux  
**Detection area:** 280°, 360° anti-creep protection  
**Degree of protection/class:** IP44 / II  
**Dimensions:** L 110 x W 68 x H 78 mm  
**Material:** UV-stabilised Polycarbonate  
**Mounting types:** wall and outside corner mountable with included plug-in socket  
**Inserting of the connection cable:** once from top down and from below  
**Range adjustment:**  
> Swivelling of the sensor head: vertically (approx. ±15°), horizontally (approx. ±45°)  
> With blank out clips (included)  
**Electrical adjustments:** in traditional manner with potentiometers valid for time and Lux value only, with infrared remote control.

## 19. Article / Part nr. / Accessory

|                                  |         |       |
|----------------------------------|---------|-------|
| <b>LUXOMAT® Motion detector:</b> |         |       |
| LC-plus 280                      | white:  | 91008 |
|                                  | brown:  | 91018 |
|                                  | black:  | 91028 |
|                                  | silver: | 91048 |

|                                 |  |       |
|---------------------------------|--|-------|
| <b>LUXOMAT® Remote control:</b> |  |       |
| IR-LC-plus (incl. wall bracket) |  | 92095 |
| IR-LCmini                       |  | 92093 |

|                    |  |       |
|--------------------|--|-------|
| <b>Accessory:</b>  |  |       |
| Arc extinction kit |  | 10880 |